

-

-

---

.

.

.

.

.

.

.

.

.

.

.

.

.

.

.

.

.

.

.

///      ///      /// ( )

:

-

( ..... )

(Channelization)

.( )

.( )

-

.

.

.

.

.

.

.

.

.

.

-

:

.

.

.

.

.( )

.

.

.

.

.

.

.

.

.

-

( )

.

--

( )  
( - )

.

--

.

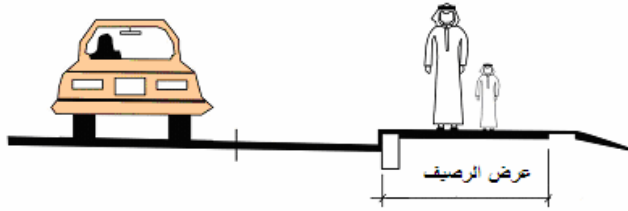

:( - )

- -

(Shy Distance)

- -

.( - )  
( - )

.(HCM)

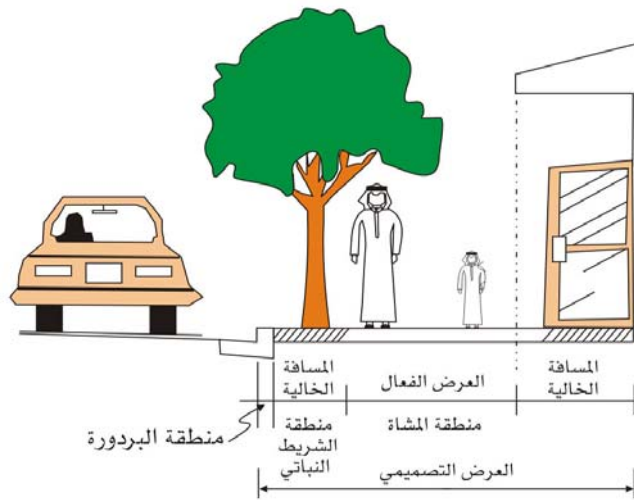

:( - )

:( - )

( )	
,	
,	
,	
,	

-

:

( )

.

:

:

:

( - )

.

.( , )

:( - )

	( )	( )	
,	,	,	
	,	,	
	,	,	
	,	,	
			( )

( - )

.( / )

( )

:( - )

( / )	( )

-

( , )

.( - )

( , - , )

. /

(Lanes)  
.( , )

.( - )

\*

:( - )

( )	( )	( )	( )
'	'	'	
'		'	
'	'	'	
'		'	
'	'	'	
'	'	'	
'		'	
'	'	'	
'	'	'	
	'	'	
	'	'	
	'	'	

// /

\*



( )

( )

( , )

( )

( - )

( )

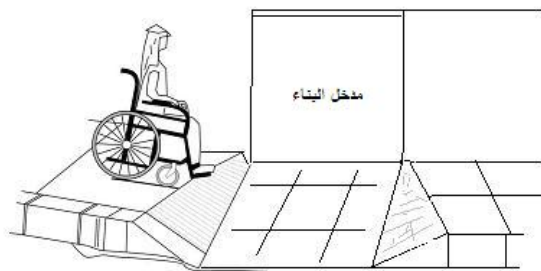

:( - )

( )

( )

.( )

( )

:  
 :  
 . ( )  
 :  
 ( )  
 : ( ) ( )  
 =  $\times ( , / , ) = \times ( / ) = ( )$   
 ( ) ( ) ( )  
 ( )

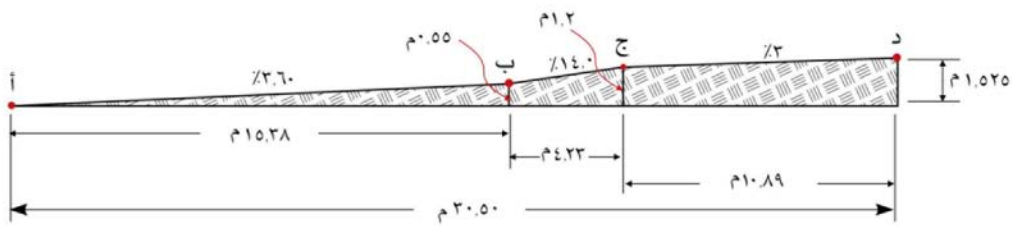

:( - )

( )  
 ( - )  
 ( ) ( ) ( )

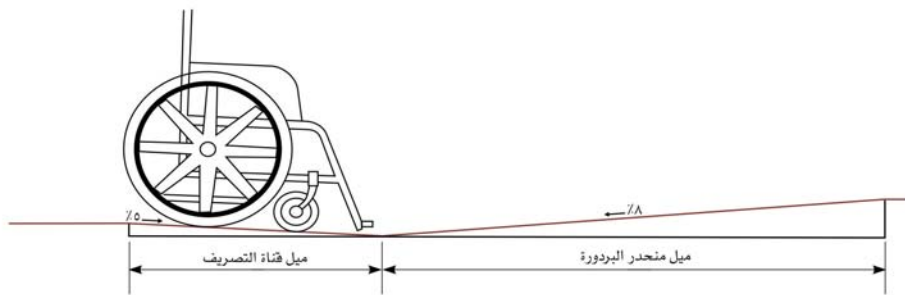

:( - )

( )

.( - )

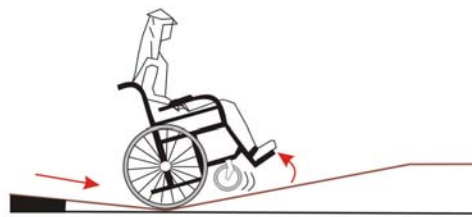
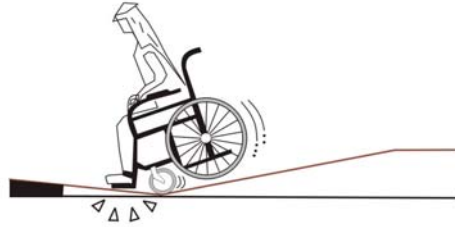

:( - )

.( )

( , × , )  
( , )

( )

.( )

( )

( )

.( - )

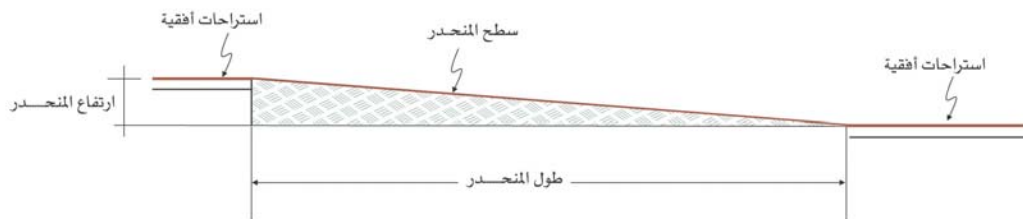

(

)

:( - )

( - )

-

.( - )

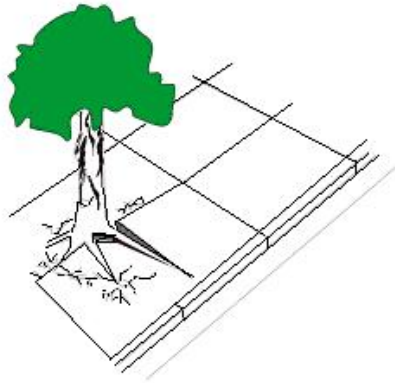

:( - )

( )

( )

.( - )

( , )

( - )

( )

( )

( , )

( )

.( - )

( )

( , )

( - )

.( - )

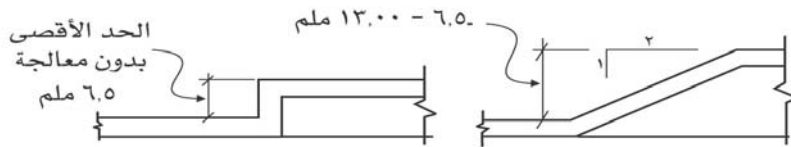

:( - )

-

:

:

( , )

.( - )

( , )

.( , )

.( , )

.( - )  
( )

( )  
( )

.( - )

:( - )

( )	( )	( )	( )	( )	( )	( )	
,	,	,	,				

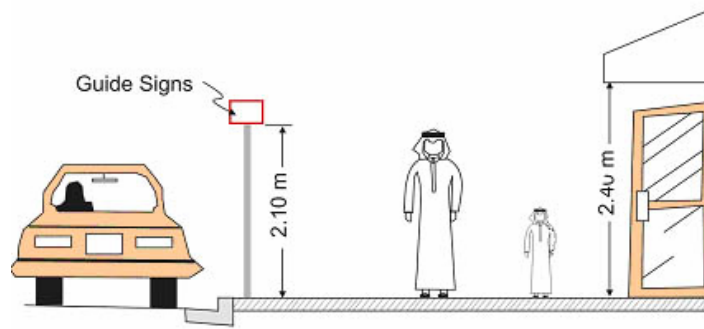

:( - )

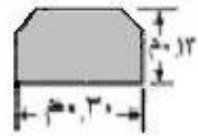

مقطع عرضي للمصدة الحاجزة  
قرب رصيف المشاة

:( - - )

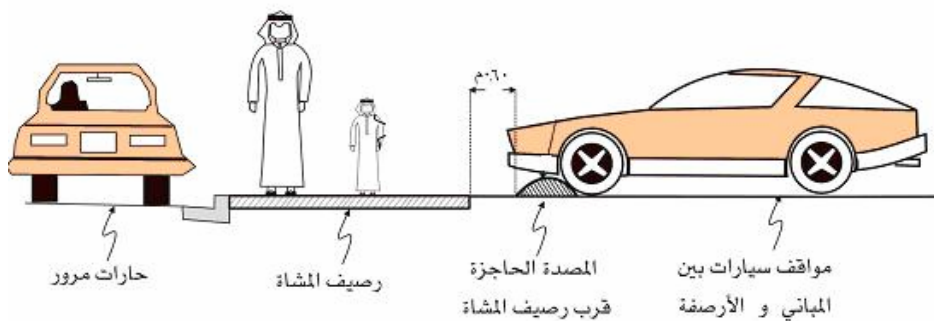

:( - - )

-

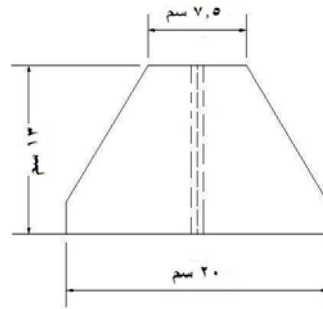
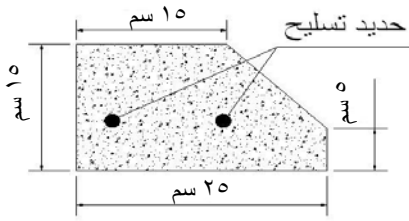
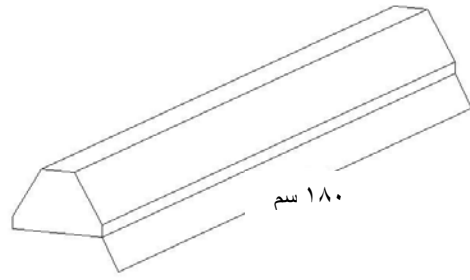
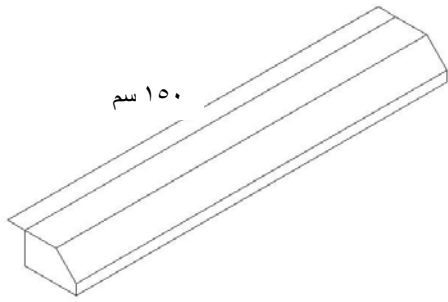

( )

( )

:( - )

-

( )

:( - )



:( - )

-

.

( )

.

:

.

.( - )

.

.

.

.( - )

.

.( - )

.( - )

( - )

.

.

.

.( - - ) ( - - )

.( - )

(

)

.

( )

.

.( - )

-

( )

( )

( )

.( - )

.( - )

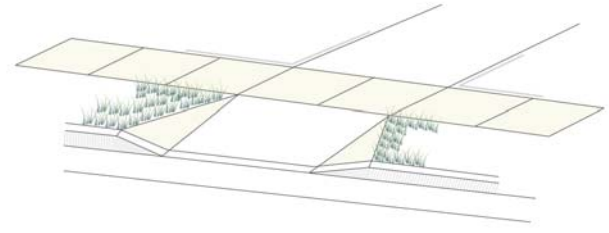
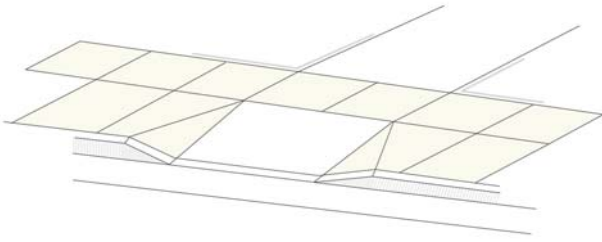

:( - )

:( - )

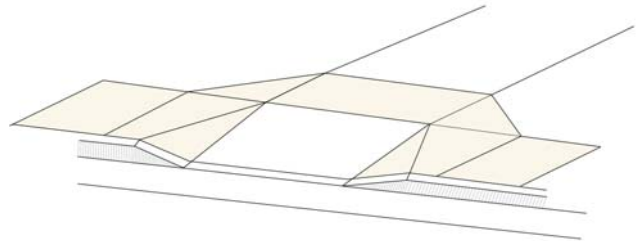
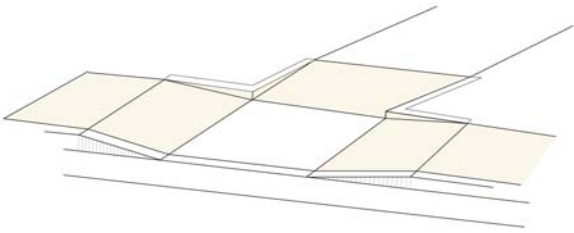

:( - )

:( - )

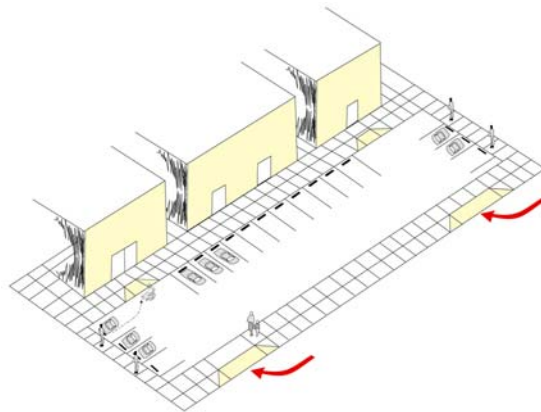

:( - )



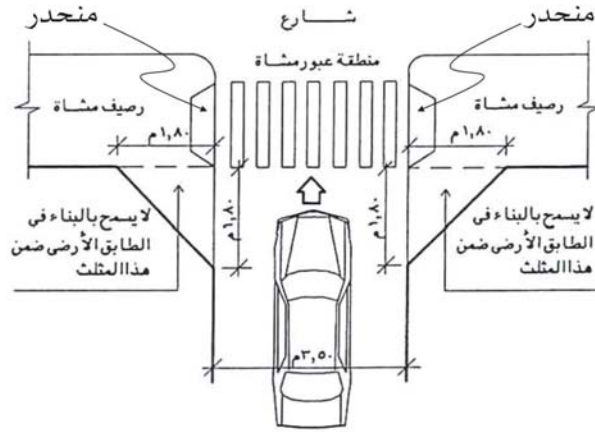

:( - - )

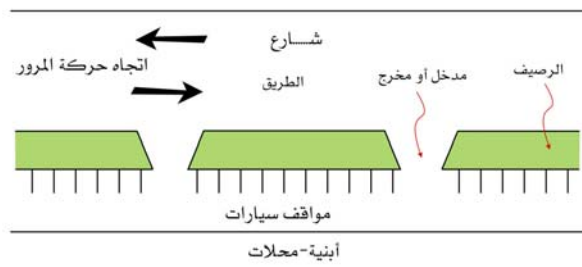

:( - - )

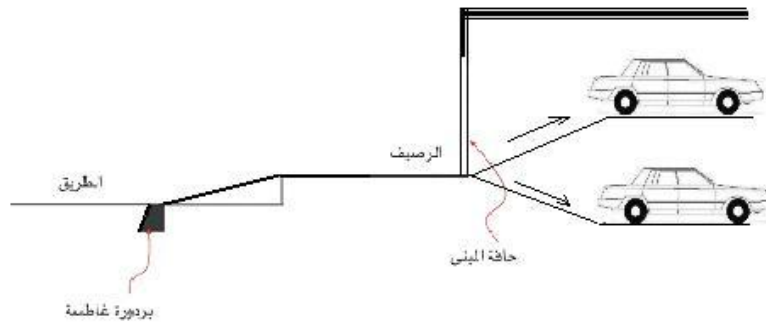

:( - )

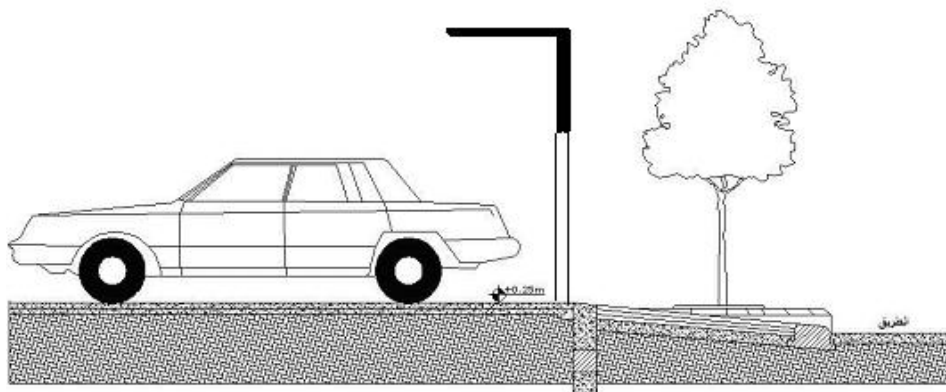

:( - )

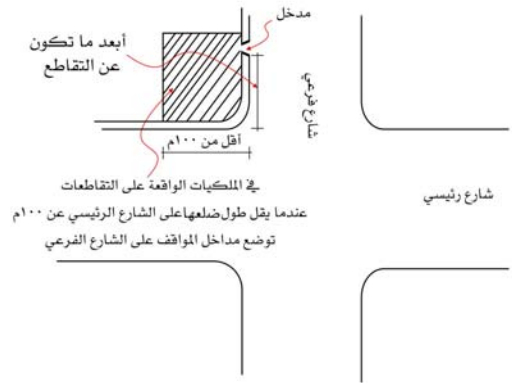

في الملكيات الواقعة على التقاطعات  
عندما يقل طول ضلعها على الشارع الرئيسي عن ١٠٠ م  
توضع مداخل المواقف على الشارع الفرعي

:( - )

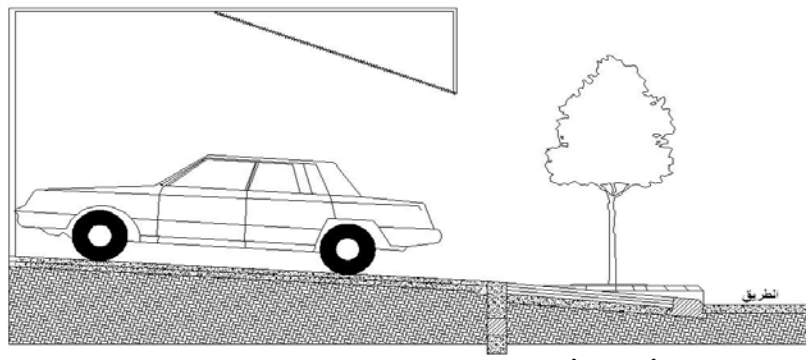

:( - )

( )

( )

.( - )

-

( - )  
:( - )  
)

- ( )			( / )
( )	( )	( )	

:

-

( / )

-

.( / )

-

--

(Inlay Tape)

( , ) ( )

( ) ( )  
( - )

( - ) (° )

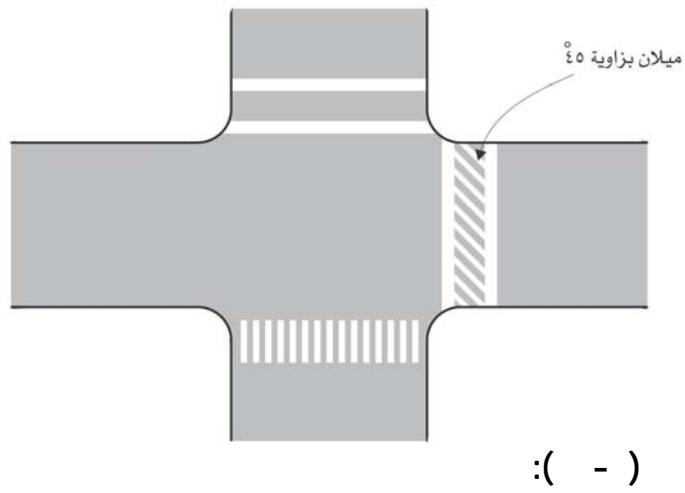

(Midblock Crosswalks)

( / )

( - )

(HCM ) ( / )

( )

-

. ( , )

. ( - - )

. ( ) ( )

( ) ( )

(Fluorescent Yellow-Green)

. ( - )

( - )

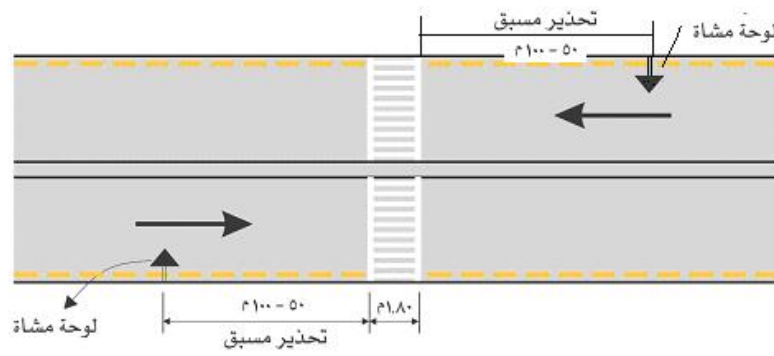

:( - )

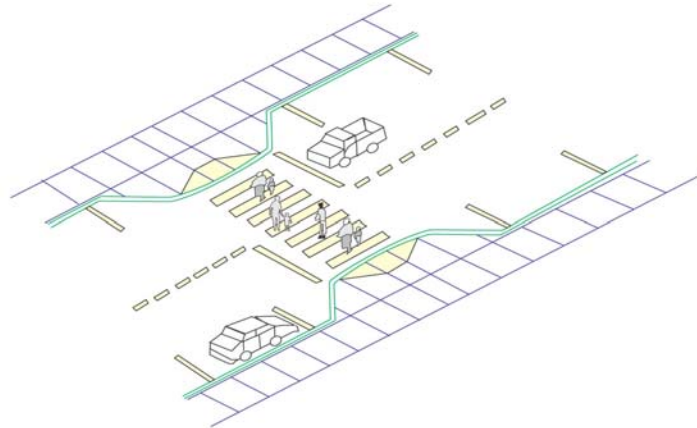

:( - )

(Speed Table)

- -

( )

( - )

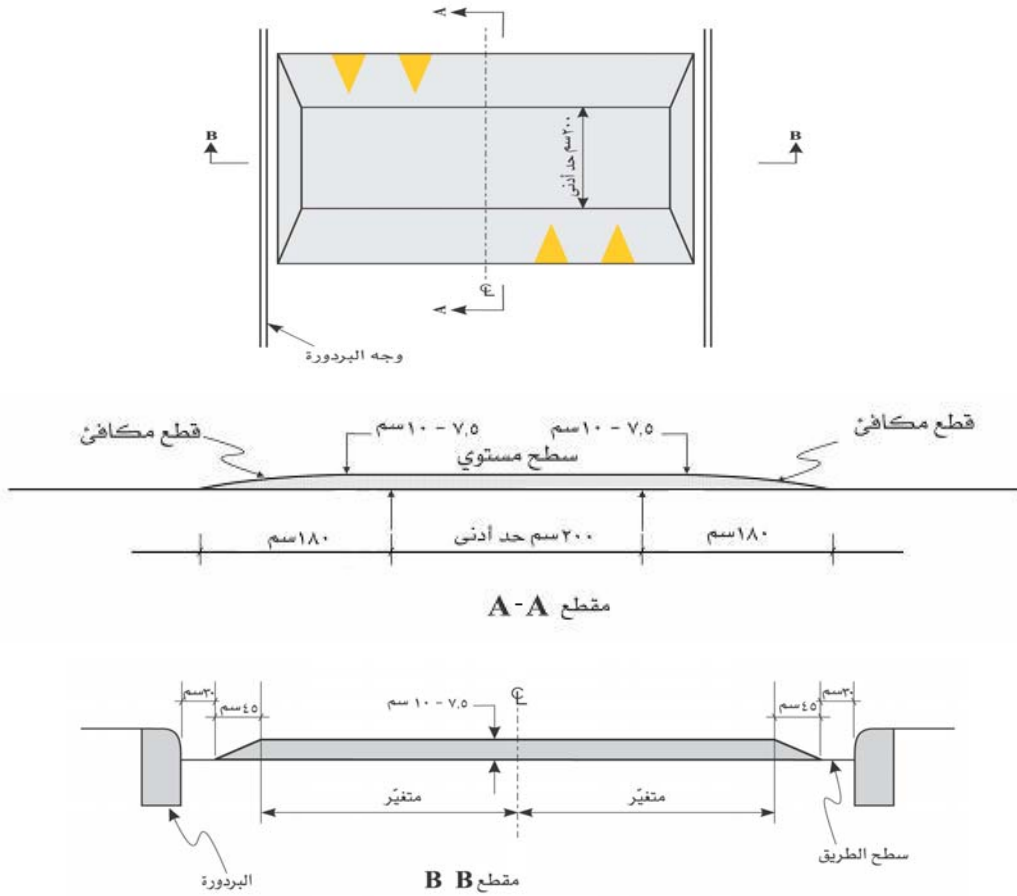

:( - )

--

( - - )

. ( ) ( )

( , )

( )

. ( - - )

( )

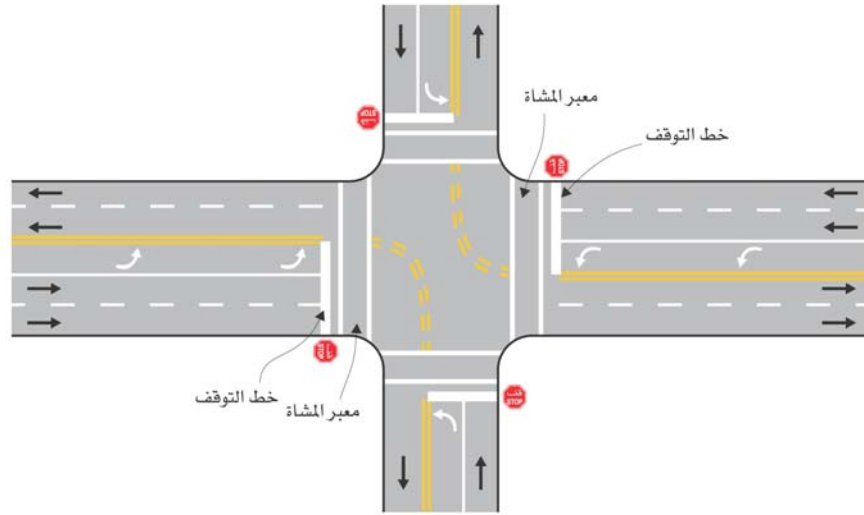

:( - - )

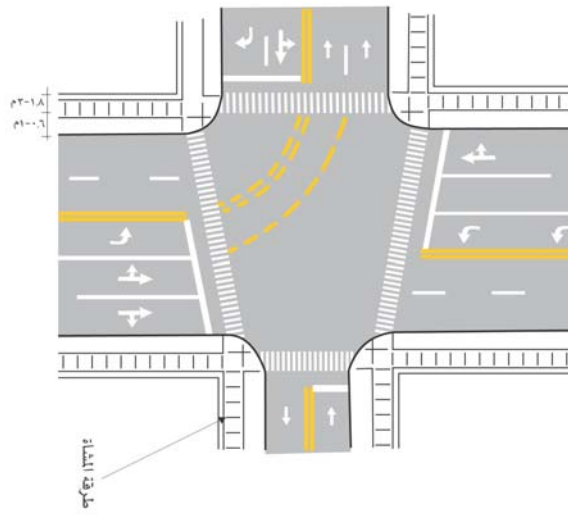

( )

:( - - )

(Grade Separated Crossings)

- -

) ( )

.(

:

(Overpasses)

-

( - - )

(Underpasses)

( - - )



:( - - )

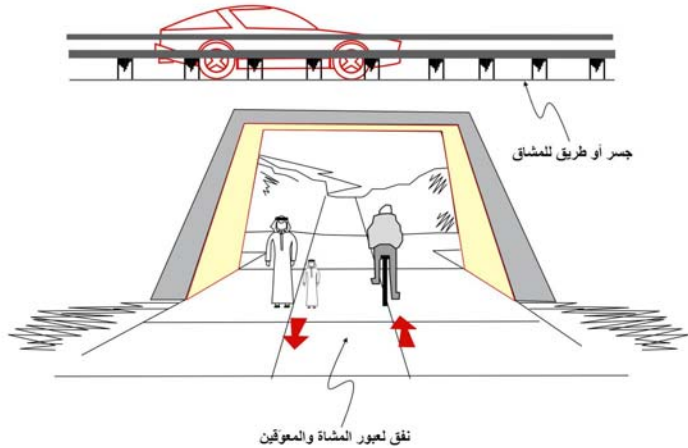

:( - - )

( )

( , )



.( )

( , )

( , )

:

( )

.( , )

( )  
.( )

( , )

.( - )

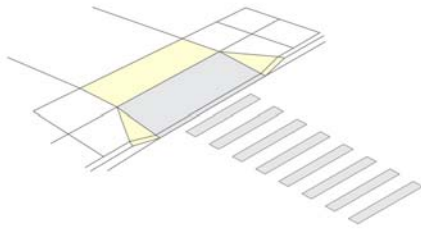

:( - )

( - )

( )

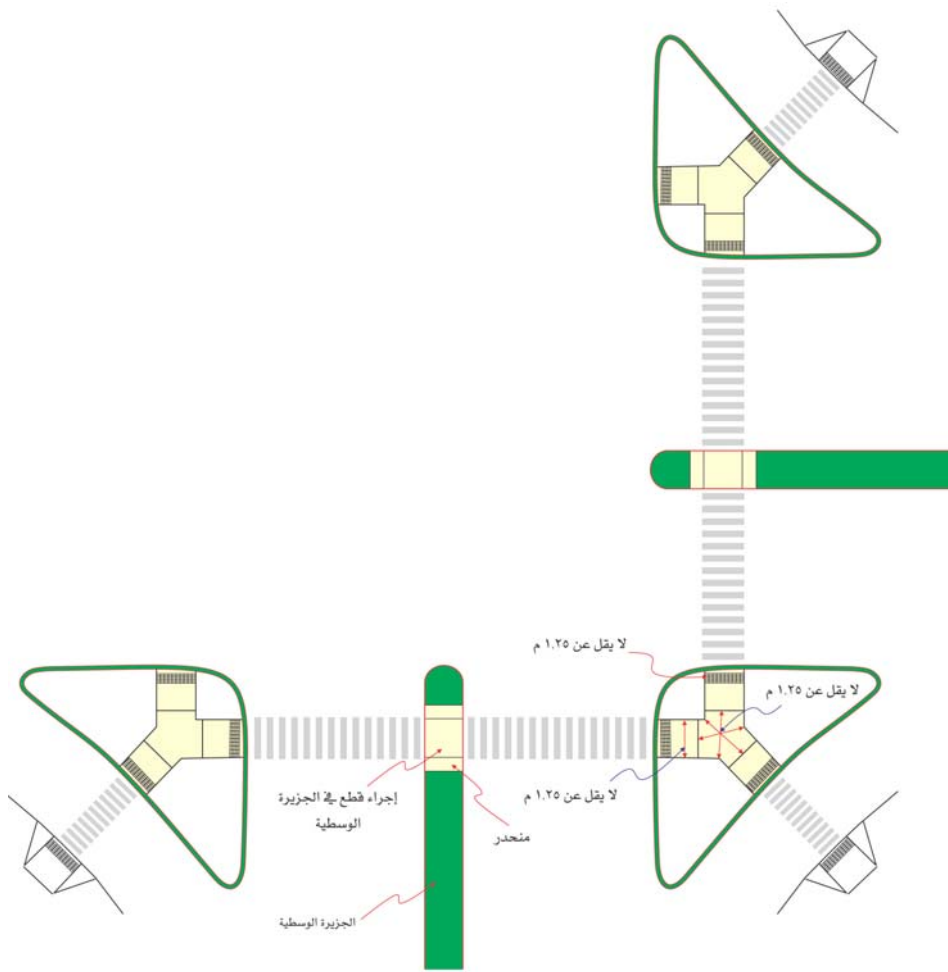

:( - )

( )

( - , )

( - )

( - ) ( )

:( - )

( )	( )	
-		
-		( )

( - )

:( - )

( )	( )	
---	, - ,	
,	, -	
,	,	
	--	
	--	
	--	

-

--

( ( ) ) ( ) ( )  
( - ) ( )  
.

( ) ( ) ( )  
( ) ( )  
( ) ( ) ( )

--

.

.

( - )

.( " " - )

:

-

•

( - )

( ) ( )  
( ) ( )

( - )

( )

•

.( - )



:( - )

( : ) ( : )

( - )

( ) ( )

( )

( , ) ( , )

( ) ( )

( )

( , )

( - )  
.( - )

( )

( )

( )  
.( - )



:( - )

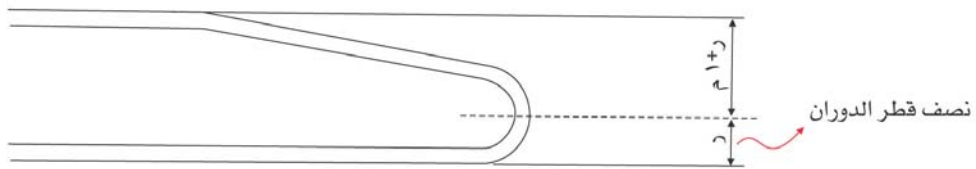

:( - )

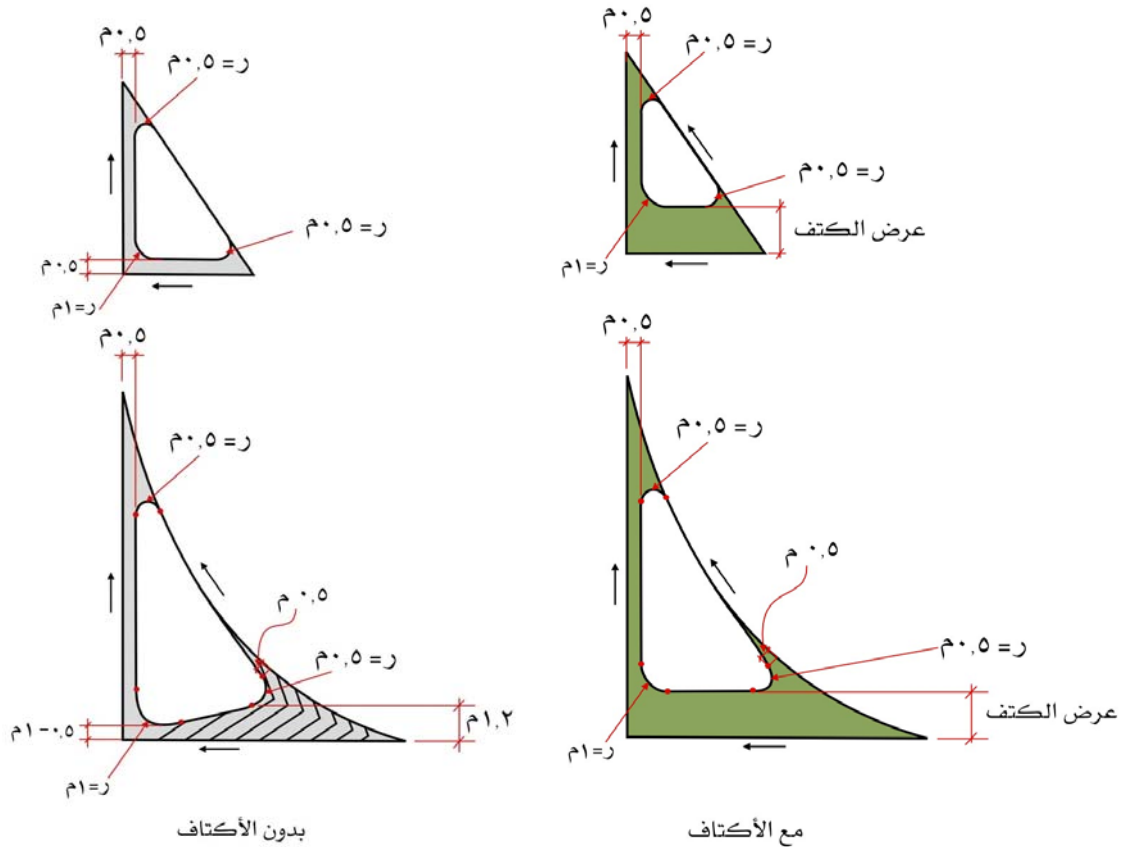

:( - )

( ) ( , )  
 .( - ) ( )  
 .( - ) ( ) ( , )

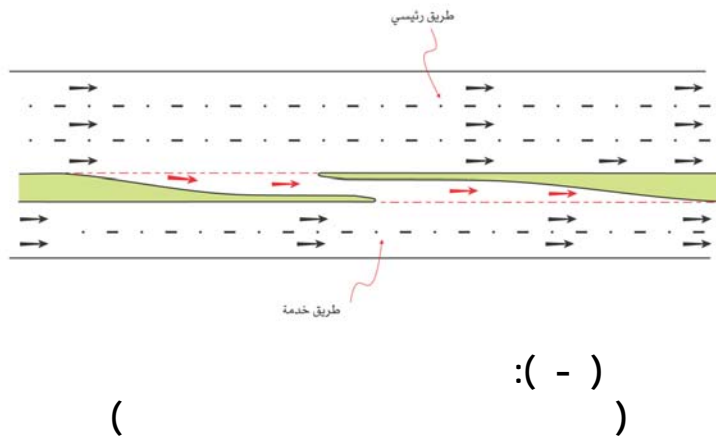
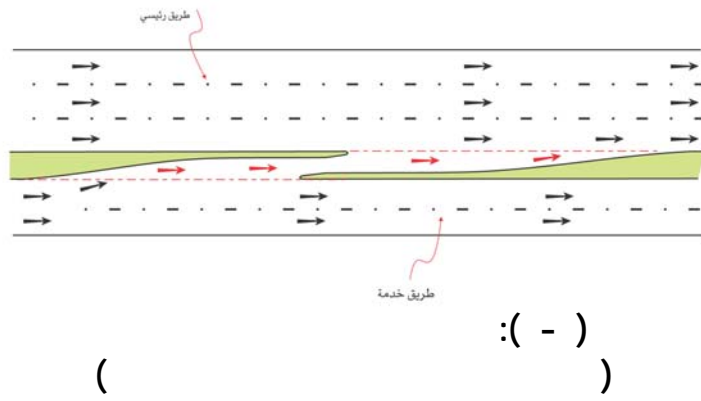

- - -  
 -  
 :  
 (S) :  
 (P) (- - )  
 (- - ) (- - )  
 (- - ) (- - )  
 (- , )  
 ( ) ( )



:( - - )

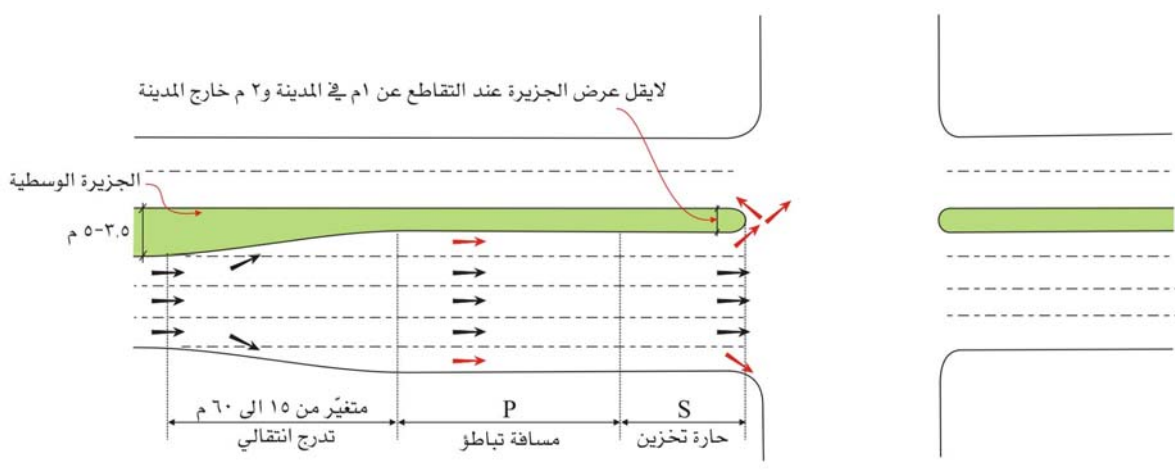

:( - - )



:( - - )

				/
				* ( ) (P)
				( ) (S)

:( - - )

				/
				* ( ) (P)
				( ) (S)

:( - - )

					/
					* ( ) ( )
	(	)		/	*

.( )

.( - )  
( )

--

:

-  
-  
-

:

-  
-  
-

:

-

-

(p)

.( - - ) ( - - )

.( - - )  
(s)

.( - )

-

( - )

( )

.( - )

( )

.( - )

( )

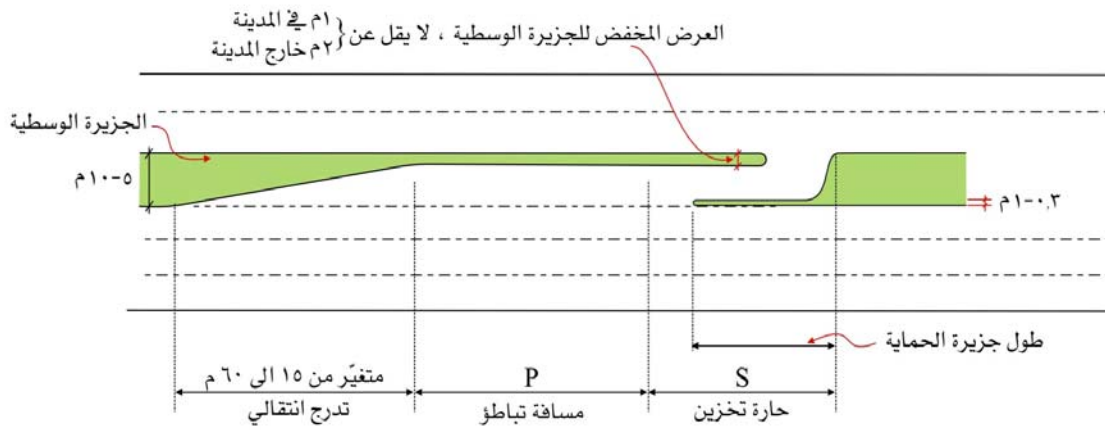

:( - )

-

( )

( - )

( , ) ( , )

( )

( ) :

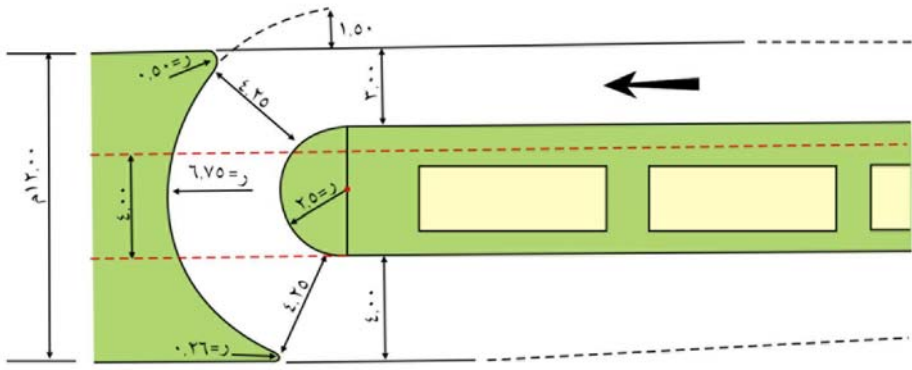

:( - )

// ( / )

)

(

( - )

( - )

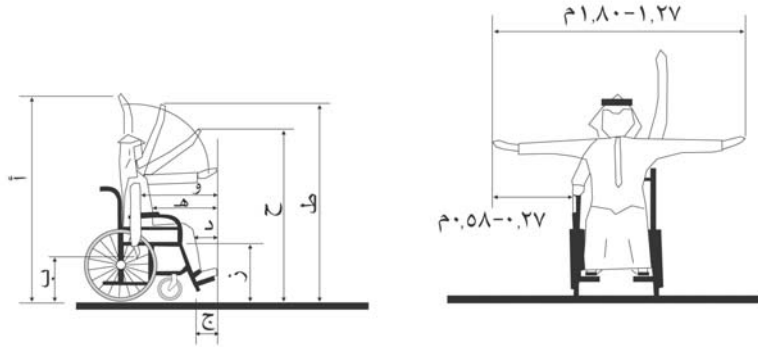
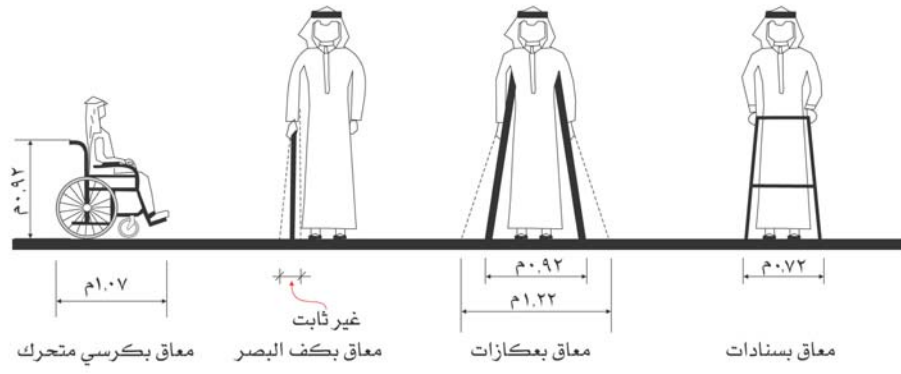

:( - )

:( - )

		*
/	/	
/	/	
/	/	
/	/	
/	/	
/	/	
/	/	
/	/	
/	/	

:( - )

: \*

( , )

( - )

( , )  
( : ) ( )  
( )  
( )  
( )  
( - )  
( )

( )



:( - )

( - )

( )

( , )

( : )  
.( - )

( , )

( )

( , )

( , )

( - )

.( - - ) ( - - )

:

( )

( , × , )

( , )

.( - - ) ( - - )

( )

( , )

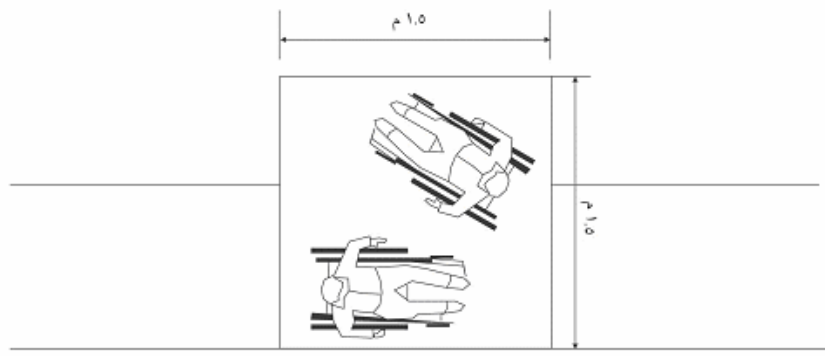

( ) : ( - - )

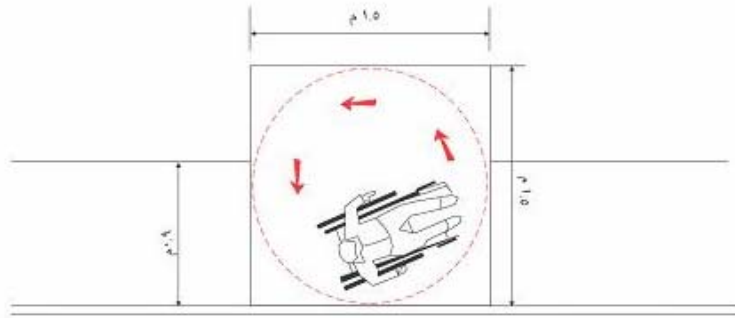

( ) : ( - - )

(Curb Ramps)

:( - )

:(Landing)

:(Approach)

:(Flare)

.( )

.( - )

:(Ramp)

.( - )

( )

:(Gutter)

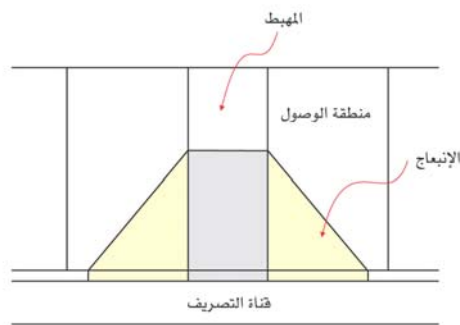

:( - )



-

--

--

.( - )

.( - - ) ( - - )

( )

, )

( , )

( , )

(

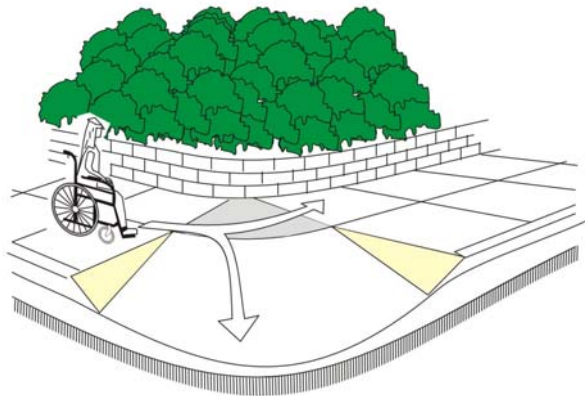

:( - )

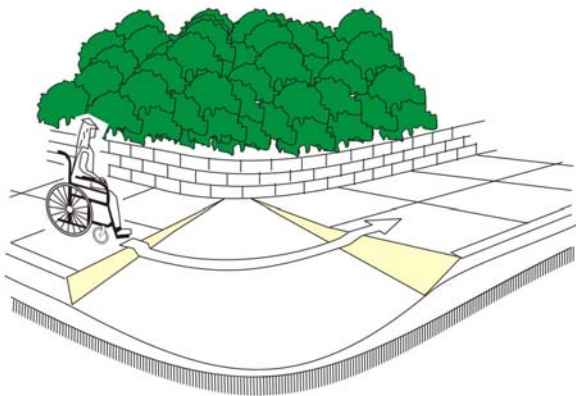

:( - - )

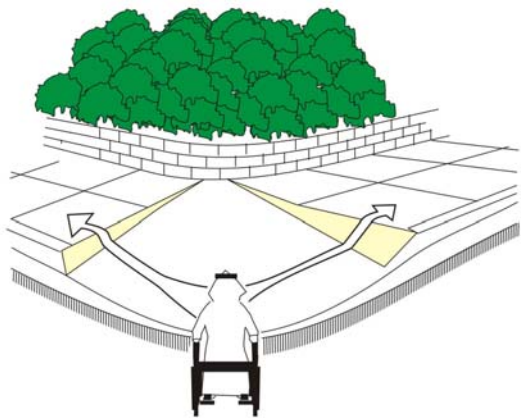

:( - - )

-

- - -

(Flare)

.( - )

( )

.( )

( , )

( , )

.( - )

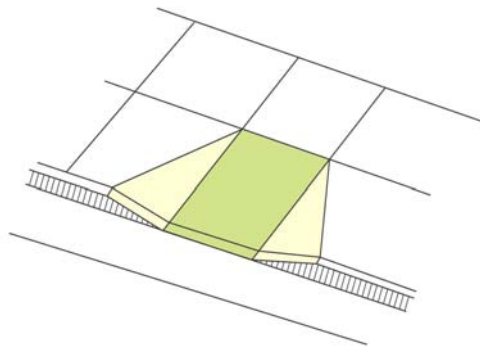

:( - )

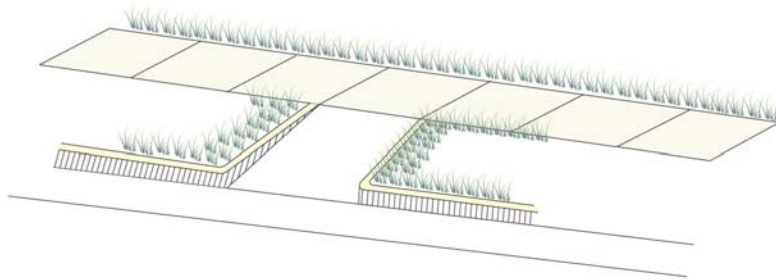

:( - )

: - - -

( )

( )

( )

( , )

( )

( - )

.( - )

( , )

-

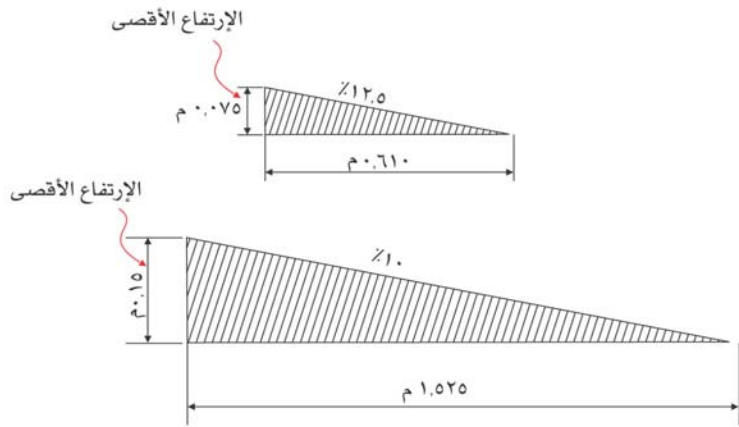

:( - )

. ( , ) ( , )

( )

( - )

:( - )

( )	( )	( )	( )	( )	( )	
,	,	,				

- - -

. ( ) ( )

" ( - ) ( - ) ( , )  
( - )

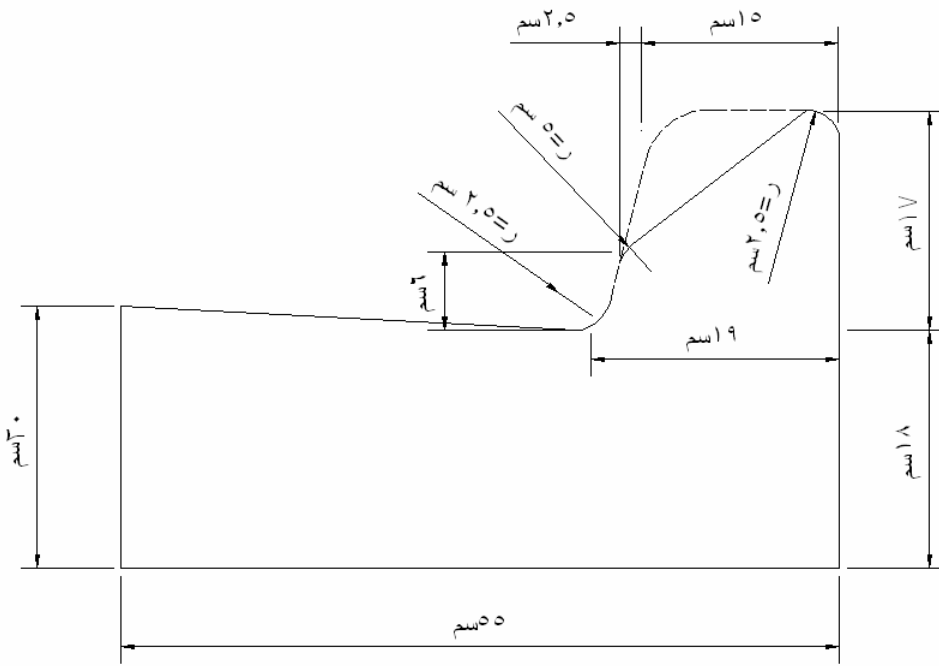

:( - )

--

--

.( - )

.( - )

.( - )

--

.( - )

( , )

- - -

( - )

( )

( - )

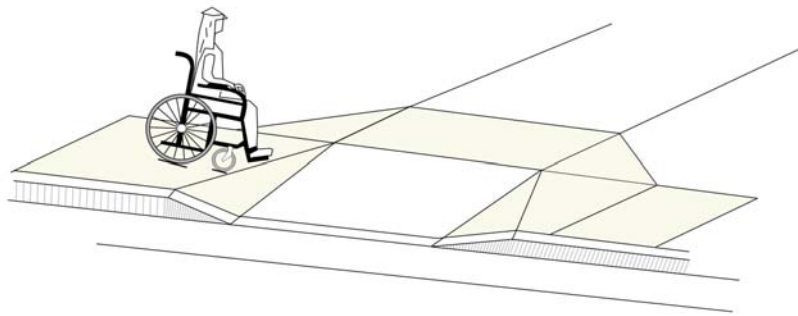

:( - )

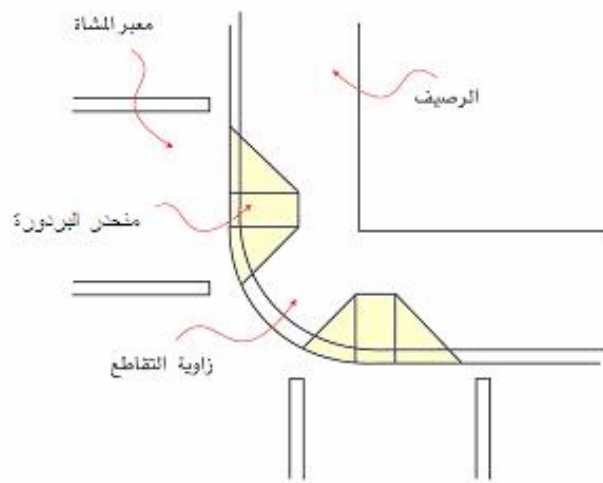

:( - )

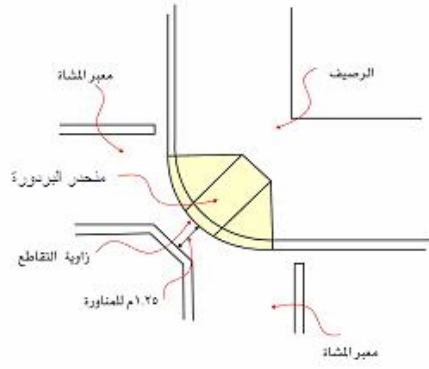

:( - )

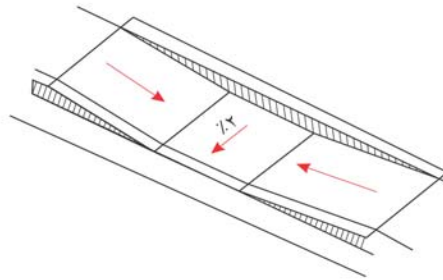

:( - )

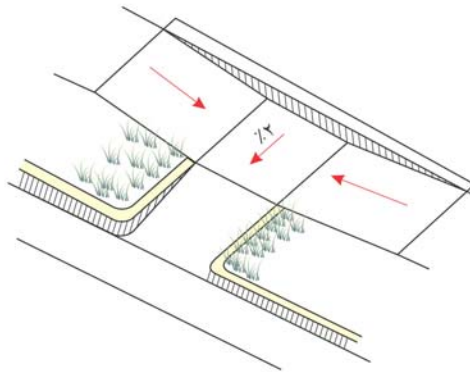

:( - )

- - -

.( - )

( - ) .

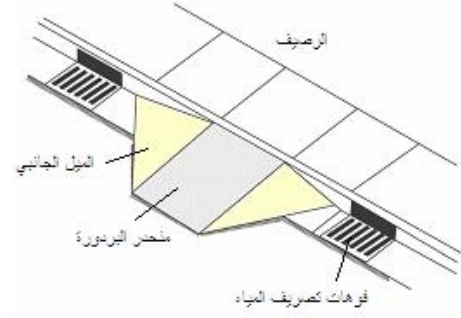
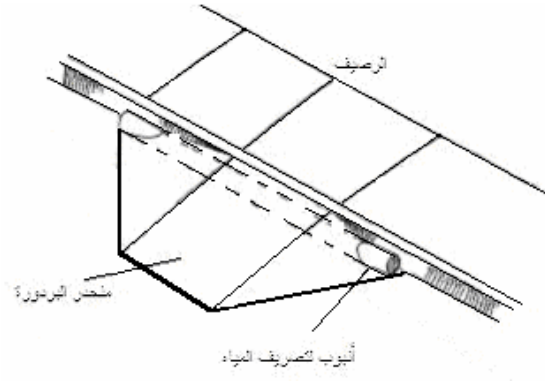

( - ) :

( )

( - )

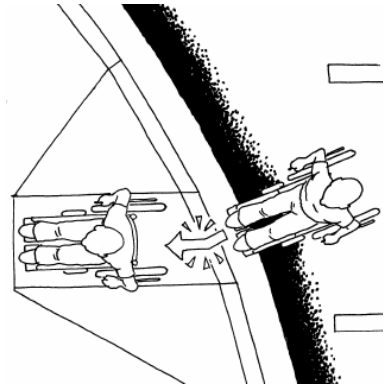

:( - )

- -

- -

.(

: )

.  
.
   
.
   
.

- - -

.( - )

( )

( )

( )



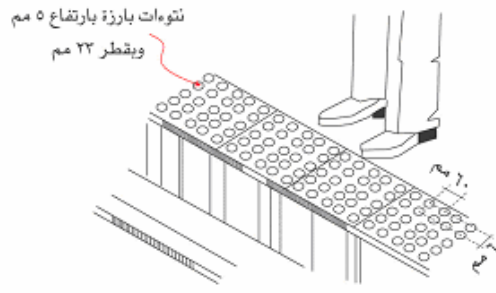

:( - )

( )

.( - )

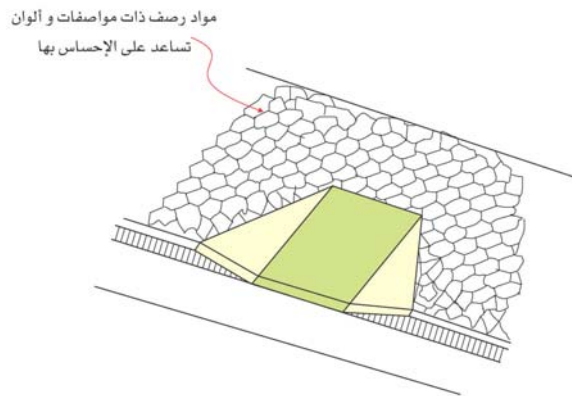

:( - )

( , )

( - )

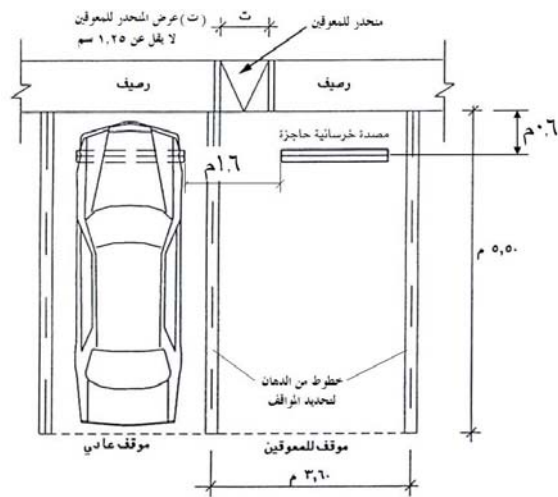

:( - )

-  
( )  
( - )  
( - )  
( )



:( - )

.( )

( - )

)  
(

( )  
( , )

.( - )

.Breakaway

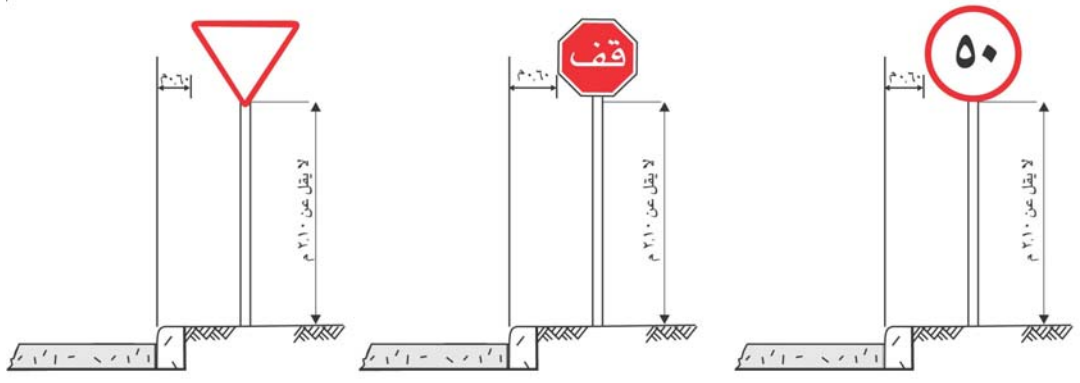

:( - )

:

( , )

(Extruded)

( )

( )

( )  
.( , )

:

-

--

:( - )  
.( )  
.( )

.  
.

--

:( - )  
.( )  
.( , )  
.( )  
.( , )  
.

.  
.  
.  
.  
.

--

( - )

.( ) ( )  
.( ) ( )  
.( )

:

.  
.  
.

--

.  
:(  
( , )  
.

( - )

.  
.

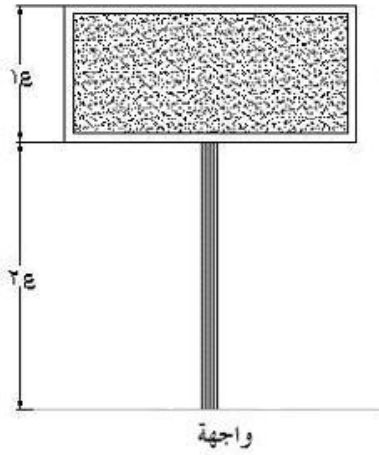

ع ١: إرتفاع اللوحة الإعلانية لا يزيد عن ٦ متر  
عمل إرتداد ٢ م من حد الرصيف  
ع ٢: إرتفاع العمود الحامل لا يقل عن ٦ متر

واجهة

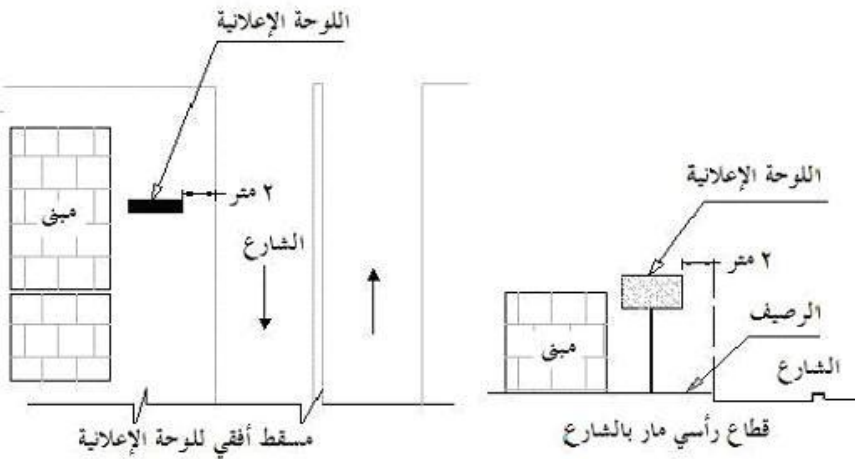

:( - )

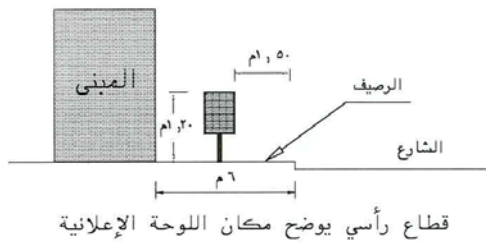
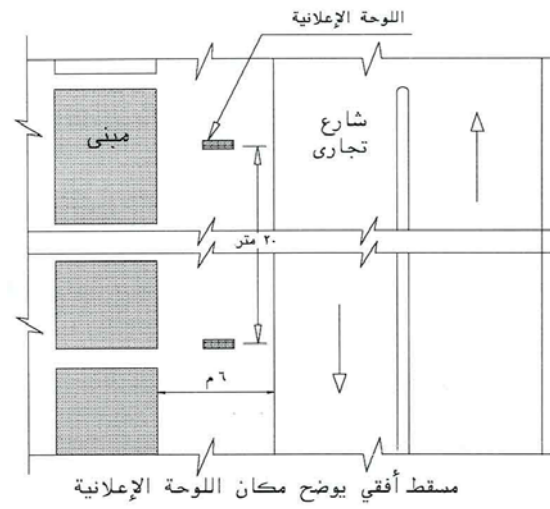

:( - )

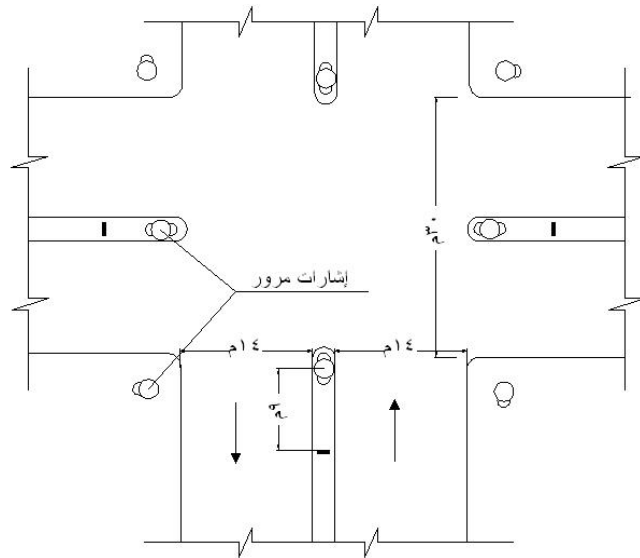

مسقط أفقي يوضح مكان اللوحة الاعلانية

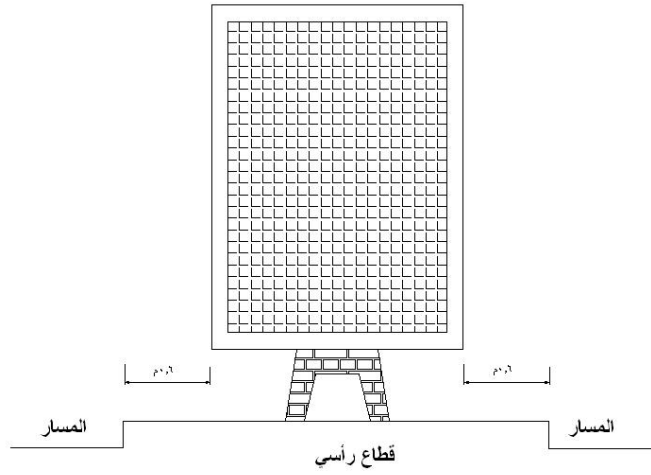

:( - )

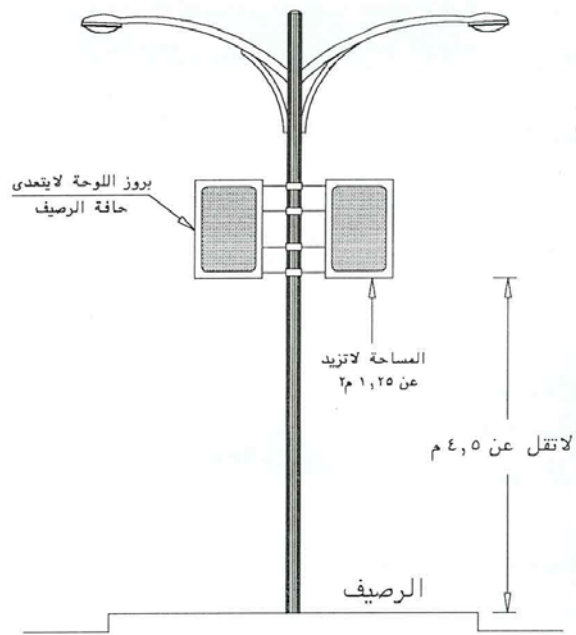

:( - )

-

-

.

.

.

:

.( - )

( , )

.

.

.

.

( )

.

.( , )

( )

( )

.( - )

:

( )

( )

.( )



-

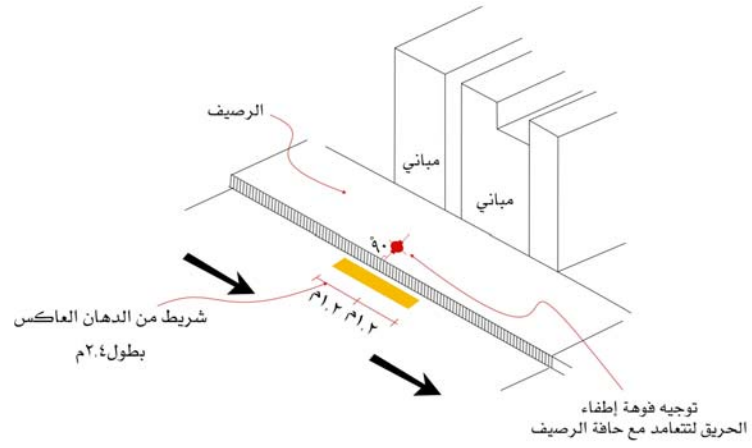

:( - )

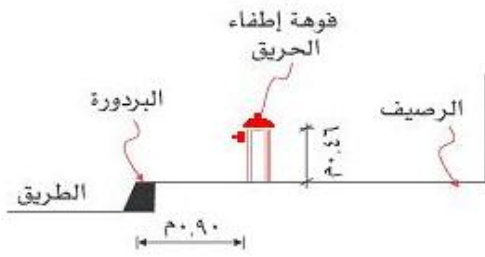

:( - )

( )

-

( , )

( )

.Fixed Object

( , )

( )

-

( )

( )  
 ( × ) ( )  
 .( - )

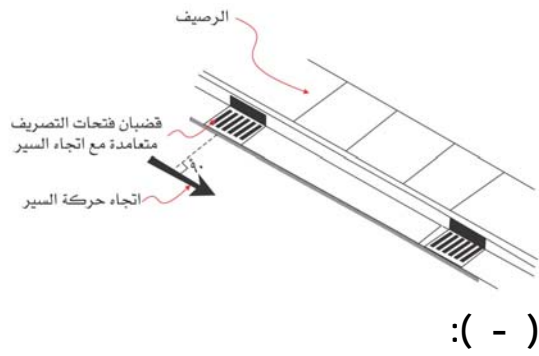

( - ) ( )



:( - )

( )

( ... )

( )

(Fixed Object)

( , )  
( )

▪  
▪  
▪  
▪

( - )

( ) ( )

( )

-

:

( , )  
( )

( )  
( - )

( )  
( - - ) ( - - )  
( )

( - )

( )

( )

( - )  
)

(

( - )

( , )

( )

:( - )

			( )
,	,	,	( )
			( )

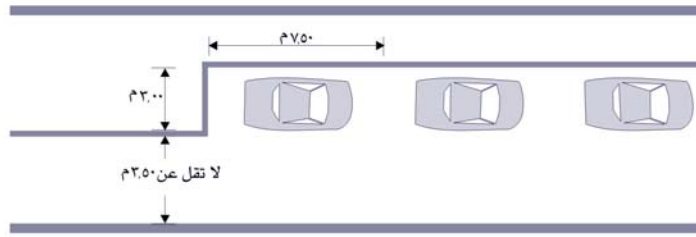

( )

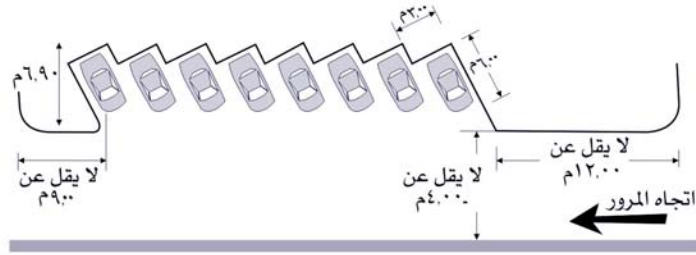

( )

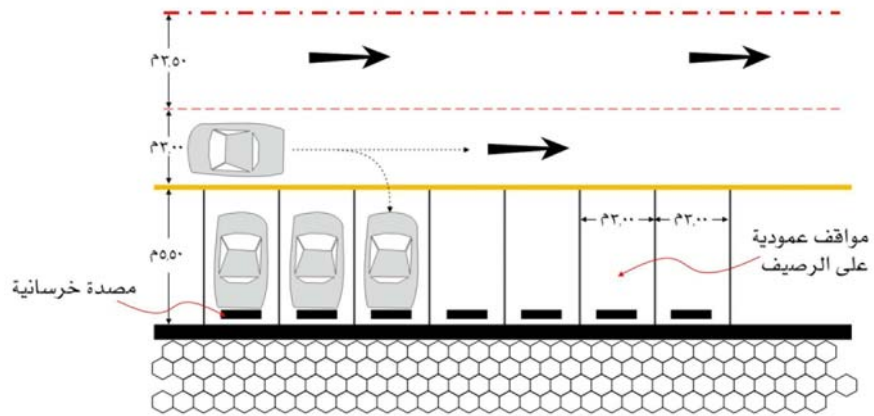

( )

:( - )

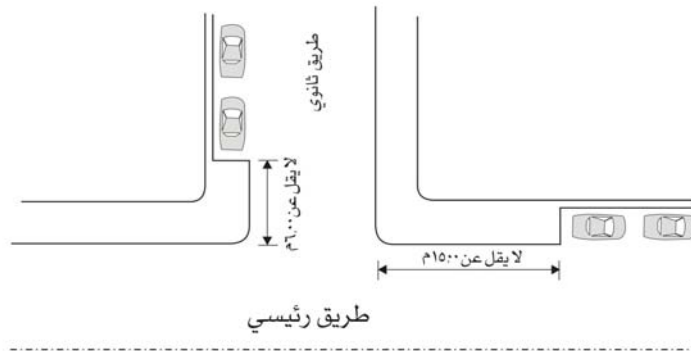

:( - - )

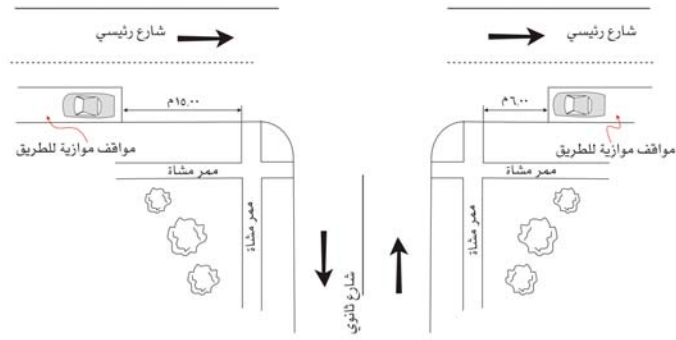

:( - - )

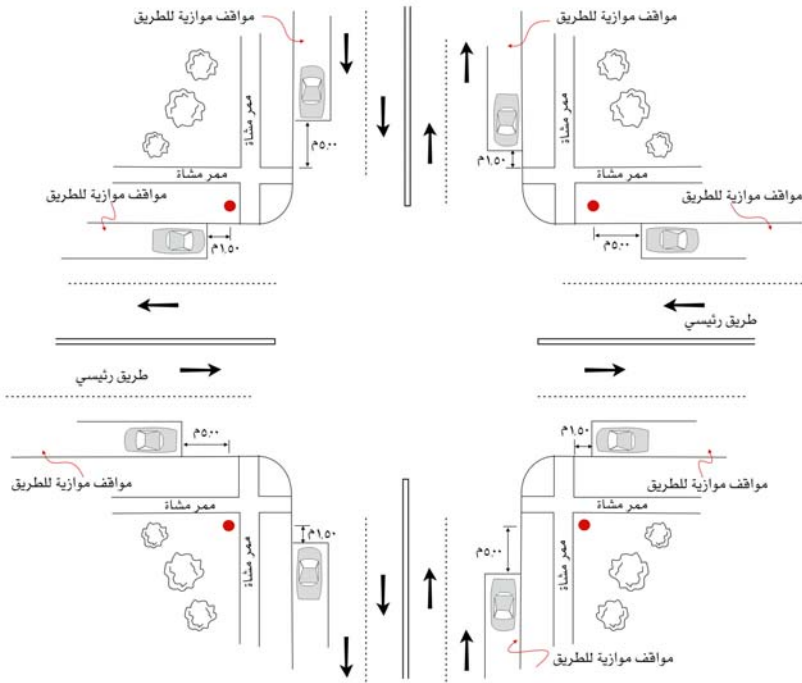

:( - )

)

(

.( - )

.( - )

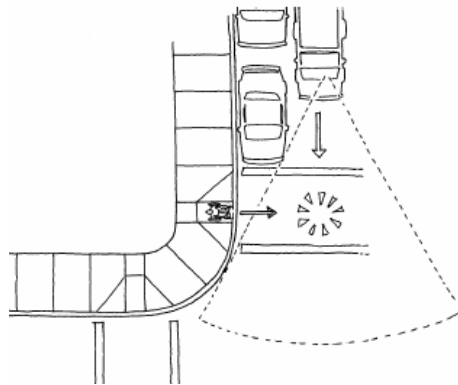

:( - )

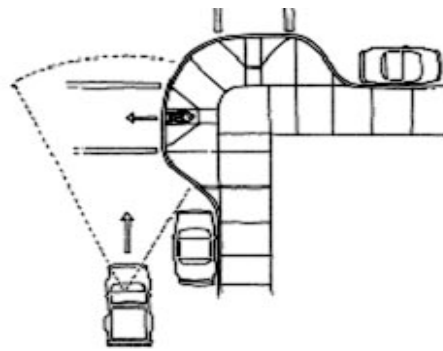
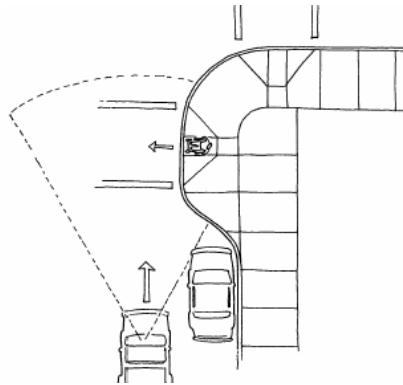

:( - )

( )

- - -

( - )

( )

( )

( , )

.( - )

.( - )

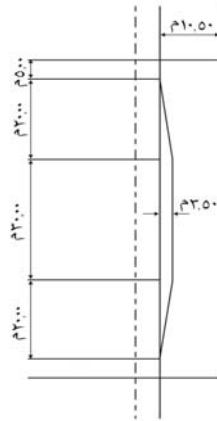

:( - )



:( - )

:

( ) ( )  
.( - )

.( - )

( )

.( - )

( )



.( - )



:( - )

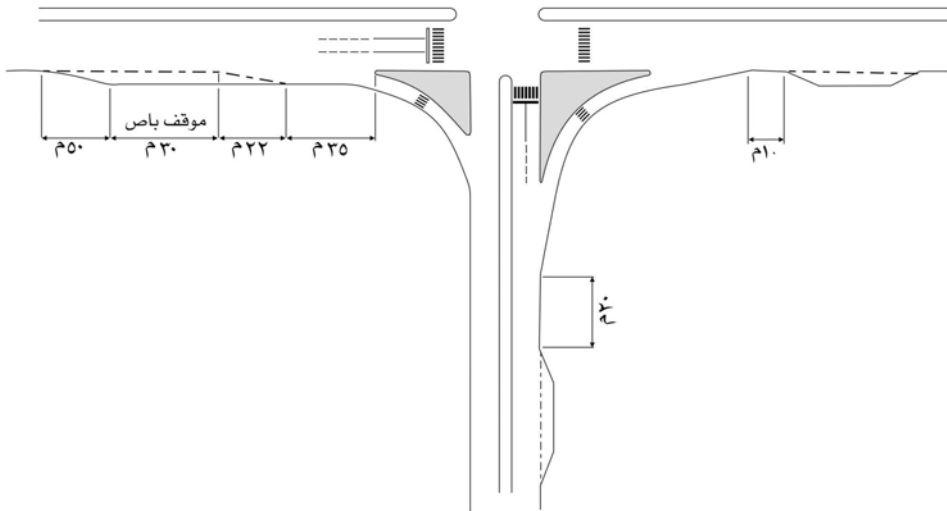

:( - )

- -

( , - )

.( - )

( )

( - )

( - )

( - )



( - )

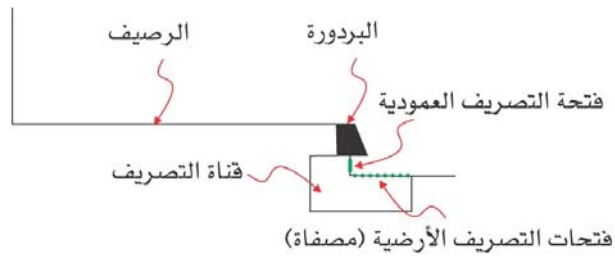

( - )

-

-  
--

.( - )

.( - )

--

.( - )

( )

( , )

.( - )

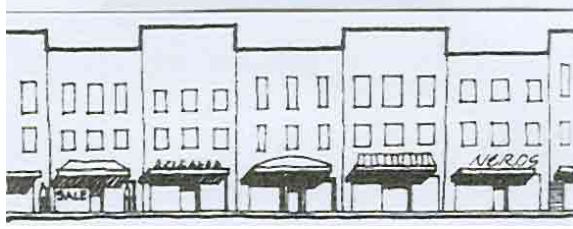

( )

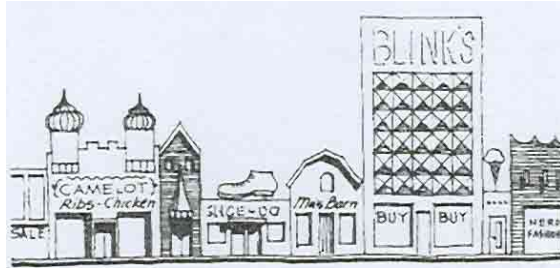

( )

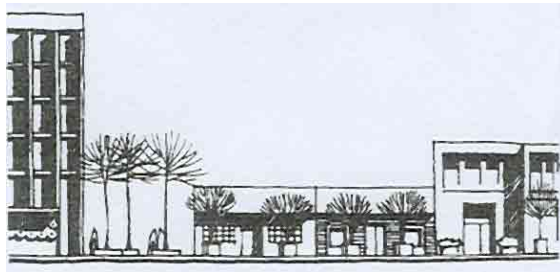

( )

:( - )

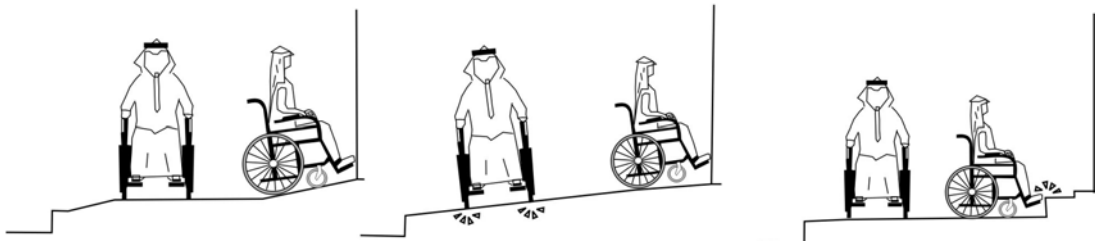

:( - )

:

.( - )

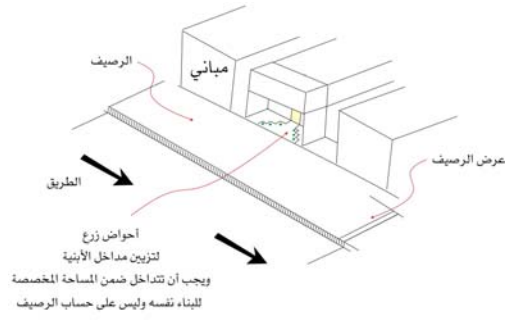

:( - )

.( - )

.( - )

.( - )

( )  
.( - )

( - )

.( - )

.( - )

( )

( )  
.( - )

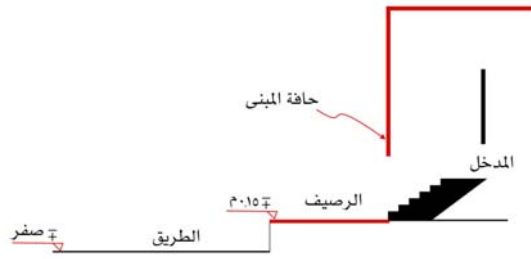

:( - )

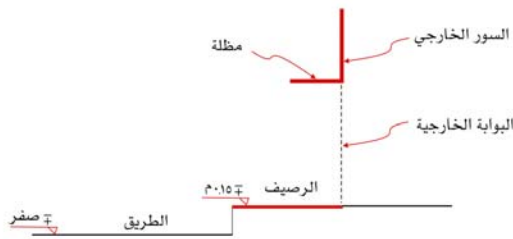

( ) :( - )

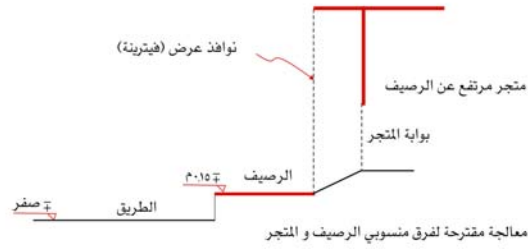

:( - )

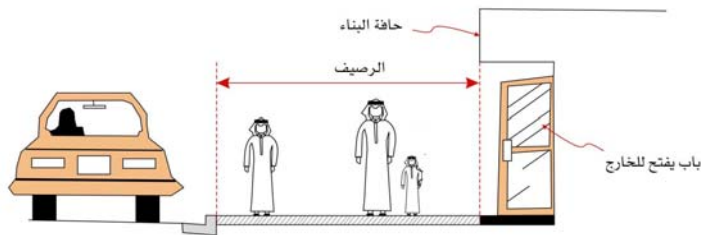

:( - )



( ) :( - )

( - ) .

( - ) .

( - ) .

( )

( )



( - ) :

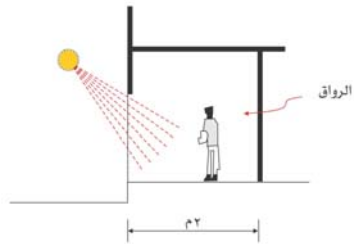

( - ) :



( - ) :

:( - ) ( )

( )

:( - )



:( - )



:( - )

:( - ) ( )

( )

:( - )

( , )

( - )

:

:( - )



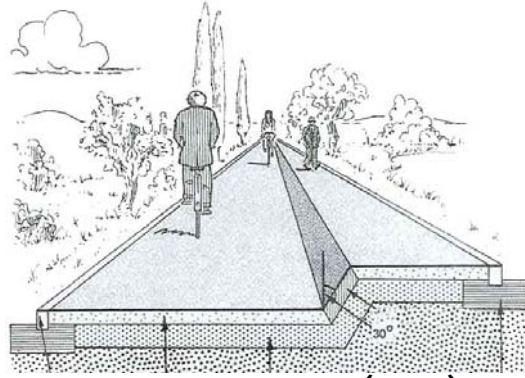

:( - )

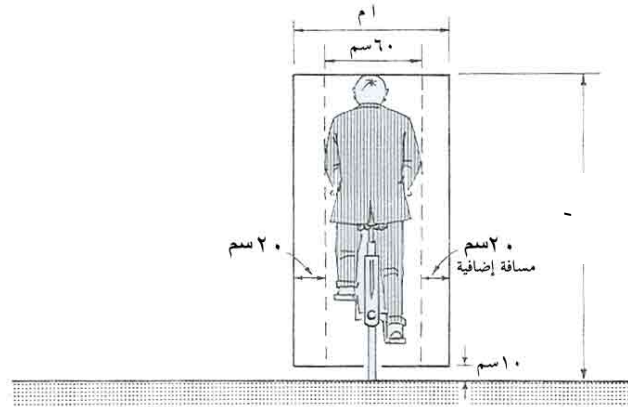

:( - )

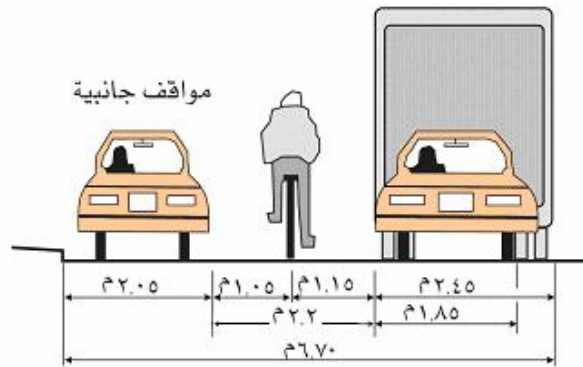

:( - )



:( - )



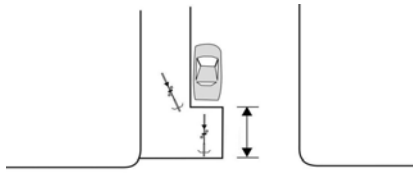

:( - )



:( - )

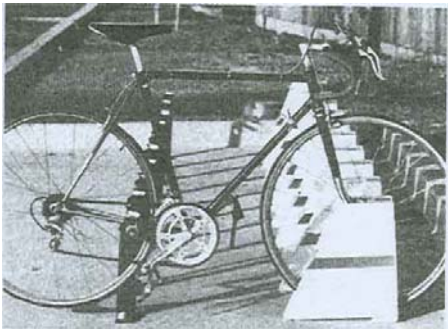

:( - )

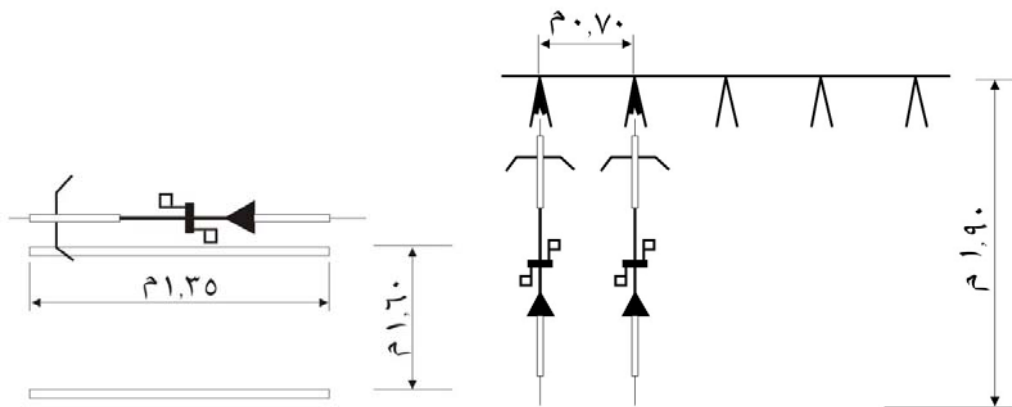

:( - )

-

-

.

-

:

.

.

-

-

-

-

-

-

-

.

.

- -

( , - , )

.( - )

:

.

.

.

.

.

.

.

.( - )



:( - )

( / )

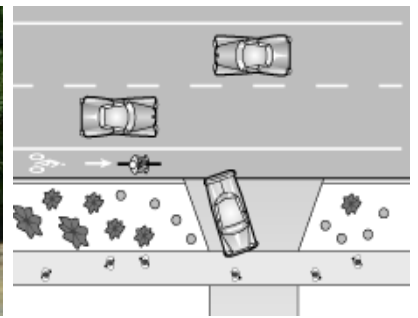
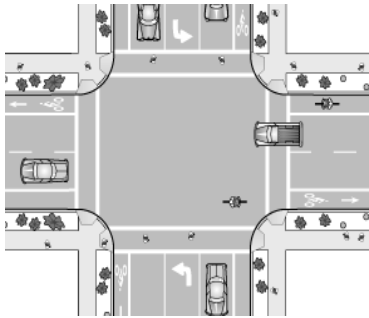

:( - )

.( - ) ( )

.( - )

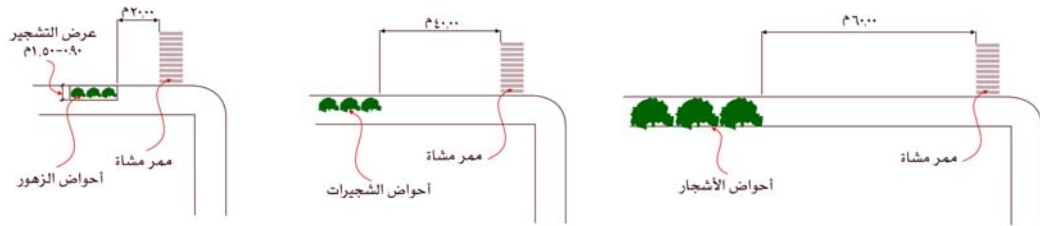

:( - )

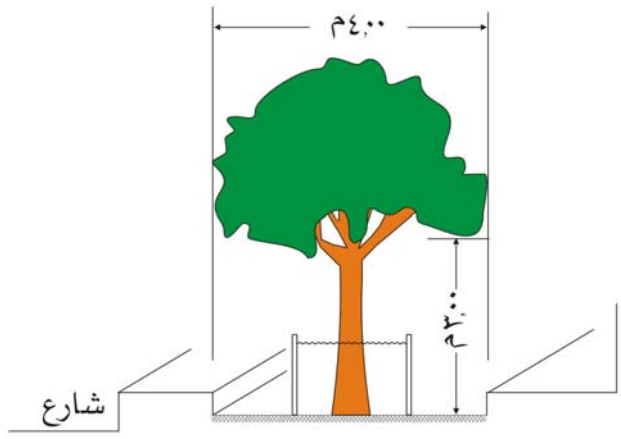

:( - )

( - )

( - )

( )

.( - )

( )

.( - )

( )

( )



( ) : ( - )

- -

( , × , )

( )

( - )

( - , )

( )

( - )

( × )  
( × )

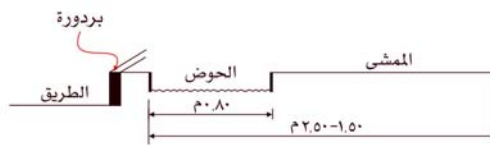
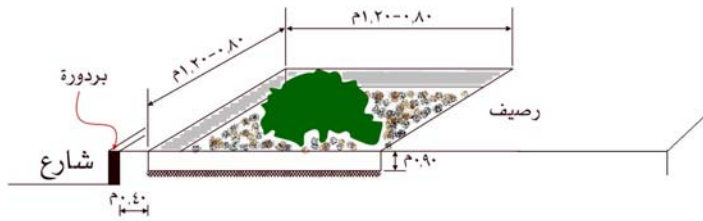

( - )

-

--

( , × , )

:

.( - )

-

-

-

-

-

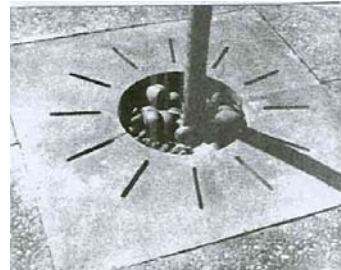
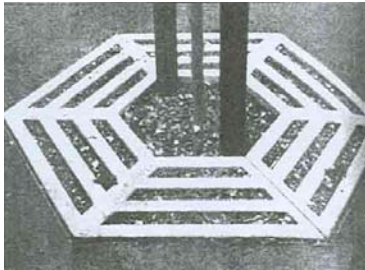

:( - )

--

-

.( - )  
.( - )

-

-

-

-

"

"





:( - )

:

( - )

:

( - )

.( )

( )

( )

-

-

:

( - )

-

-

-

-

-

-

-

-

( )

( )

( )

( )

( )

( )

( )

( , )

-

.( - )



:( - )

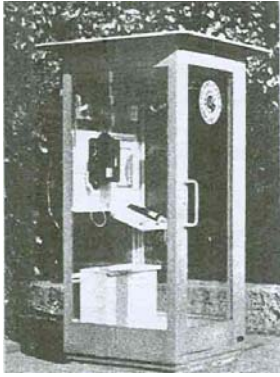

:( - )

..

.( - )



:( - )

..

.( - )

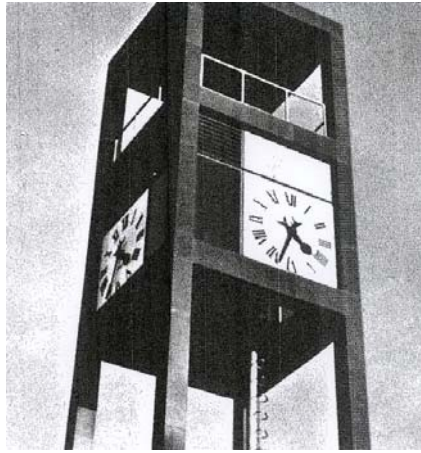
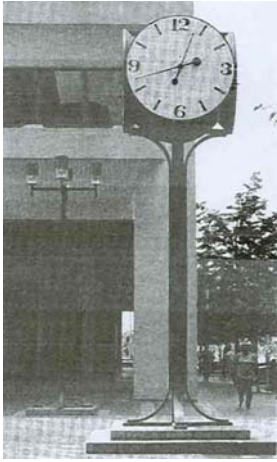

:( - )

- -

.( - )



:( - )

- -

-( - )

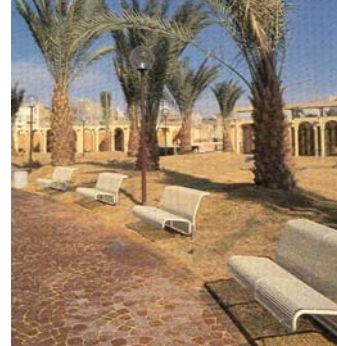

:( - )

-( - )



:( - )

-( - )



:( - )

- -

.( - )



:( - )

Pollard

- -

.( - )



:( - )

-

-

:

.( )

.

.

.

.

-

( )

:

.(	)	(	)	▪
.(	)	(	)	▪
.(	)	(	)	▪

:

( )  
.( - )

( , )



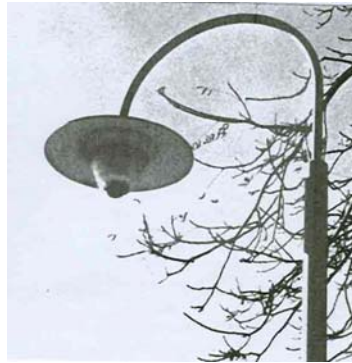

:( - )

( , )

( , )

:

.( - )

- 
- 
- 



:( - )

.( - )



:( - )

:

.( - )

.(Stamped Concrete)

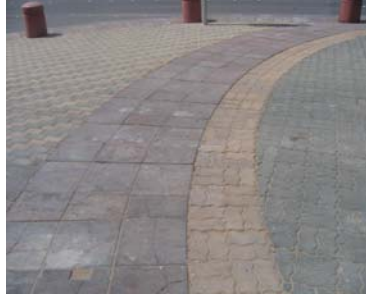

:( - )

(Patterns)

.( - ) ( - )



:(- - )



:( - - )



:( - )

( )

× )

.( )

.(

-

:

-

:

-

:

-

.

-

.

-

.

-

"

"

.

:

.( / )

.( )

-

.( )

)

.( )

( )

.( )

Thermoplastic

( , )

(

( , )

( )

)

-

.(MUTCD)

:

( )

( )

( )

(Breakaway)

( , )

:

-

-

-

-

-

- -

(Thermoplastic)

- -

( - )

(Thermoplastic)